

COM2

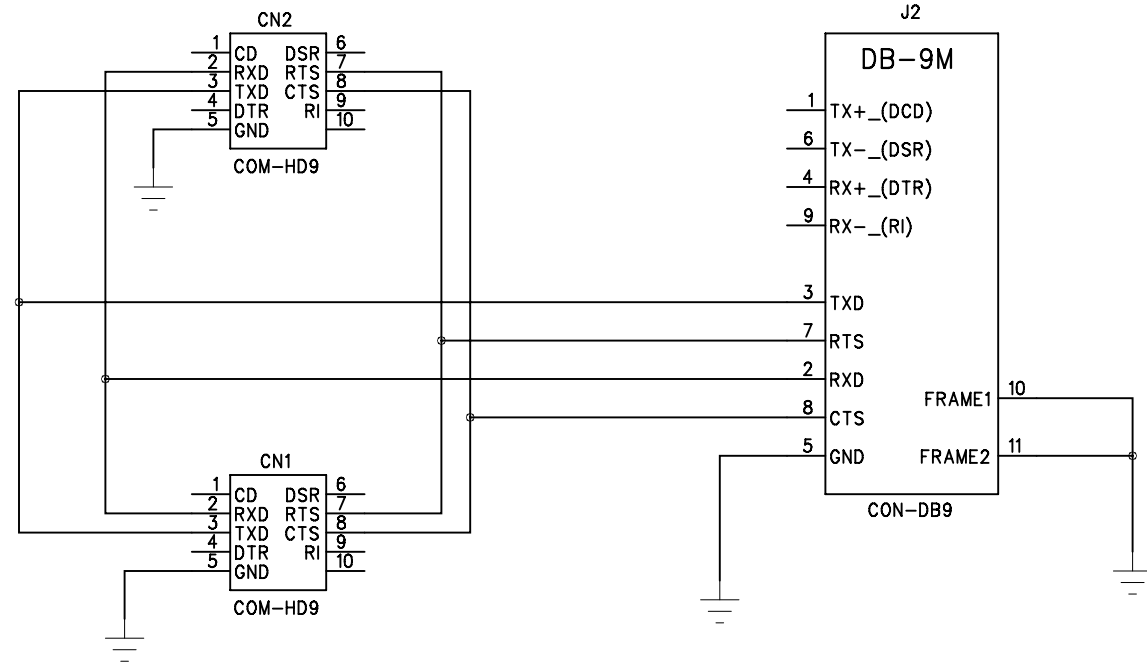

COM1

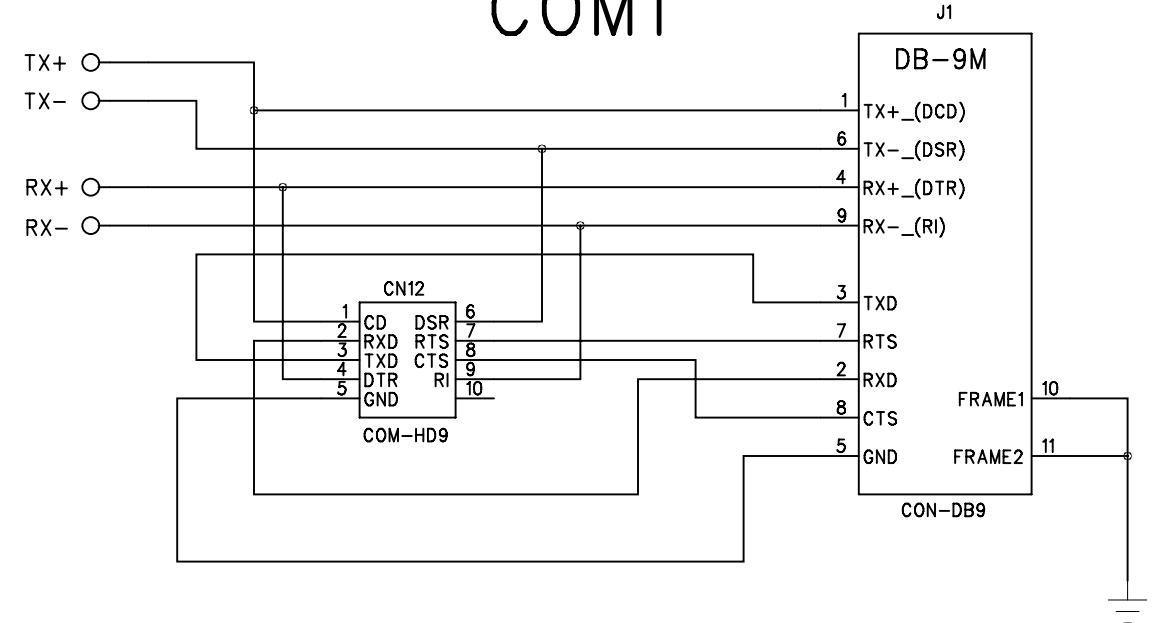

COM2

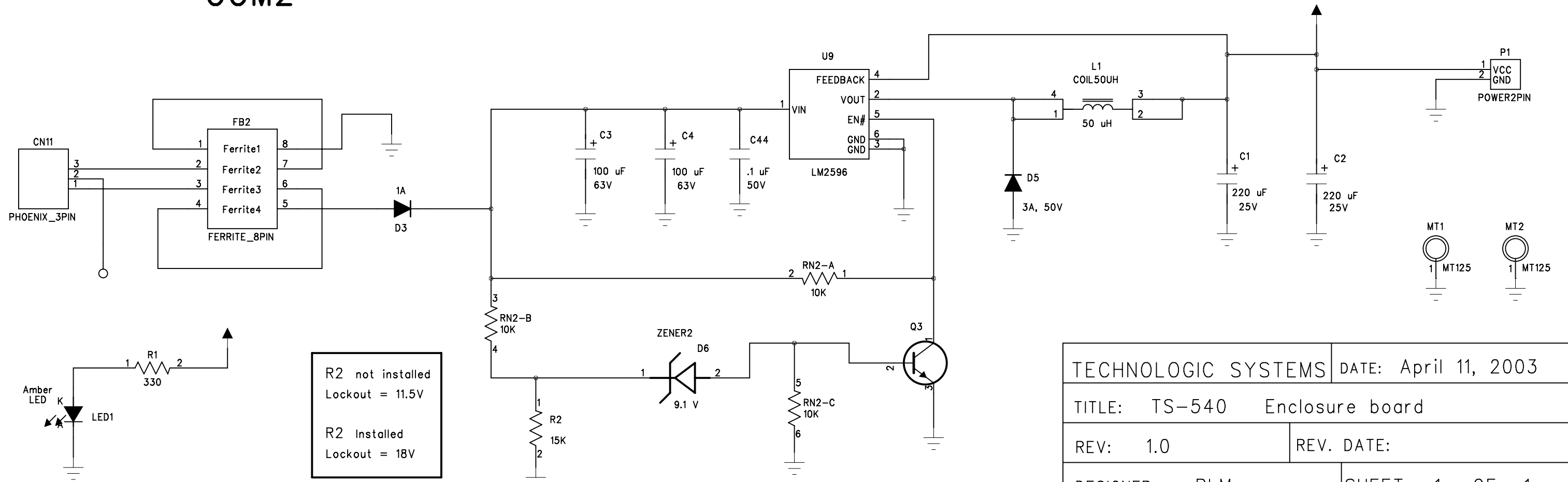

R2 not installed
Lockout = 11.5V

R2 Installed
Lockout = 18V

TECHNOLOGIC SYSTEMS	DATE: April 11, 2003
TITLE: TS-540 Enclosure board	
REV: 1.0	REV. DATE:
DESIGNER: RLM	SHEET: 1 OF 1